



European Committee for Standardization
Comité Européen de Normalisation
Europäisches Komitee für Normung

CEN/ISSS WS/BII06

Procurement

PROFILE DESCRIPTION

Business Domain: Post award procurement

Business Process: Ordering - Billing

Document Identification: CEN/ISSS WS/Profile BII06

Version: 1.0

Release: 2009-11-05

Date of approval: 2009-11-05

Document Summary

This profile describes a process comprising an electronic (purchase) Order, an electronic Order Response, an electronic Invoice, and, potentially, an electronic Credit Note. Billing anomalies are resolved by the issuing of a Credit Note or a subsequent Corrective Invoice.

The Order may refer to a framework agreement for its terms and conditions; otherwise the Customer's terms and conditions apply.

The Order may contain items (goods or services) with item identifiers and items with free text description. Acceptance or rejection of the Order in full is communicated by the Supplier to the Customer in an Order Response.

Following purchase and delivery, the Supplier sends the Customer an Invoice that makes reference to the Order. Invoice disputes may be resolved by way of a Credit Note, a Corrective Invoice or by providing additional supporting documents. Notification of dispute is external.

This profile may cover invoice factoring arrangements.

Contributors

- NES - North European Subset, Version 2.0 (nesubl.eu)
- CEN/ISSS WS/BII Working group 1

TABLE OF CONTENTS

1	Preamble.....	4
1.1	Profile description.....	4
2	References.....	5
3	Business benefits and requirements.....	6
3.1	Business benefits	6
3.2	Business Requirements	6
4	Profile detailed description	7
4.1	Context	7
4.2	Business process in scope	8
4.3	The actors involved in this profile are:.....	8
4.4	Choreography of business collaborations	9
4.4.1	Profile business rules	11
4.5	Business collaboration(s) detailed description	11
4.5.1	Ordering collaboration	Error! Bookmark not defined.
4.5.2	OrderResponse collaboration	Error! Bookmark not defined.
4.5.3	Invoicing collaboration.....	Error! Bookmark not defined.
4.5.4	ResolveInvoiceDispute collaboration	Error! Bookmark not defined.
4.6	Transaction(s) detailed description	16
4.6.1	Transaction data models	16
4.6.2	SubmitOrder transaction	Error! Bookmark not defined.
4.6.3	RejectOrder transaction	Error! Bookmark not defined.
4.6.4	AcceptOrder transaction	Error! Bookmark not defined.
4.6.5	SubmitInvoice transaction	Error! Bookmark not defined.
4.6.6	CorrectWithCredit transaction	Error! Bookmark not defined.
4.6.7	CorrectWithInvoice transaction	Error! Bookmark not defined.

1 Preamble

The CEN/ISSS Workshop on business interoperability interfaces for public procurement in Europe (CEN/ISSS WS/BII) was established in order to

- Identify and document the required business interoperability interfaces related to pan-European electronic transactions in public procurement expressed as a set of technical specifications, developed by taking due account of current and emerging UN/CEFACT standards in order to ensure global interoperability;
- Co-ordinate and provide support to pilot projects implementing the technical specifications in order to remove technical barriers preventing interoperability.

To facilitate implementation of electronic commerce in a standardized way, thereby enabling the development of standardized software solutions as well as efficient connections between business partners without case by case specification of the data interchange, the workshop agreed to document the required business interoperability interfaces as profile descriptions. The end goal is to reduce the cost of implementing electronic commerce to a level that is economical for small and medium size companies and institutions.

1.1 Profile description

A profile description is a technical specification describing

- the choreography of the business process(es) covered, i.e. a detailed description of the way the business partners collaborate to play their respective roles and share responsibilities to achieve mutually agreed goals with the support of their respective information systems,
- the electronic business transactions exchanged as part of the business process and the sequence in which these transactions are exchanged,
- the business rules governing the execution of that business process(es), its business collaborations and business transactions, as well as any constraints on information elements used in the transaction data models
- the information content of the electronic business transactions exchanged by pointing to a given data model for each of the business transactions.

As well as determining what business transactions are used, the profile restricts their content in terms of elements and the cardinality of elements. The key standardization aspect of the profile description is thus on the organisational and semantics interoperability levels rather than on syntax within the technical interoperability level. Consequently the business transactions within a profile can be structured based on different message standards/syntax as long it contains all the necessary data elements.

Although the profile descriptions and transaction data models provided by CEN BII will be neutral of syntax, the workshop has agreed to provide specifications of how its data models may be mapped to defined syntaxes. This is done in order provide the market with implementable specifications.

It should be noted that the profile description does not attempt to address issues related to topics such as:

- the actual transmission of the electronic messages,
- security and confidentiality of the message exchange,
- integrity, authentication and auditing of information content or
- the process of implementing a solution based on the profile description.

These issues have however been addressed by other deliverables of the CEN/ISSS WS/BII (see section 2 for reference to relevant documents).

The main focus of the profile description and the associated transaction data models is to address generally expressed business requirements applicable throughout the European market. Although the profile description and associated transaction data model are designed to meet generally expressed requirements, it is still the responsibility of the users to ensure that the actual business transactions exchanges meets all the legal, fiscal and commercial requirements relevant to their business.

2 References

External documents

- UN/CEFACT Modelling Methodology (available at <http://www.untmg.org/specifications/>)
- UMM Meta Model – Foundation Module Version 1.0, Technical Specification, 2006-10-06
- UMM Meta Model – Base Module Version 1.0, Technical Specification, 2006-10-06
- UML (Unified Modelling Language), version 2.0
- UN/CEFACT ebXML Core Components Technical Specifications version 2.01 – ISO 15000-5
- UN/CEFACT Business Requirements Specification version 1.5 (CEFACT/ICG/005)

Related publications from CEN/ISSS WS/BII:

- CWA xxxx-1: Profile Overview
- CWA xxxx-1, annex A: Glossary of terms
- CWA xxxx-1, annex B: Profile Architecture
- CWA xxxx-1, annex C: Controlled Vocabulary Approach
- CWA xxxx-2: UBL-UN/CEFACT convergence (WG2)
- CWA xxxx-3: Toolbox Requirements (WG3)
- CWA xxxx-4: Pilot Support (WG4)

3 Business benefits and requirements

3.1 Business benefits

The main business benefits to be gained by the implementation of this profile are:

Aspect	Beneficiary	Benefit
Process automation	Customer	Systematic acquisition process.
Automated Order Processing	Supplier	Electronic delivery of the Order allows automated Order processing and facilitates redeployment of resources.
Automated Invoice Processing	Customer	Automated matching of the Invoice with the Order eliminates human keying errors and facilitates redeployment of resources. Reduced requirement for manual intervention leads to fewer human keying errors. Automatic Invoice validation. Potential for systematic Invoice processing. Resource redeployment.
Automated Invoice Transfer	Supplier	Faster Invoice transfers. Potential for shortened payment cycle and improved cash flow.
Customer relations	Supplier	Closer Customer relations. Increased trust in received Orders.

3.2 Business Requirements

1. The Customer sends an electronic Order that can be received and processed by the Supplier. The Order may contain supporting documents.
2. The Supplier sends an electronic Order response, stating whether the Order is accepted or rejected in full. The Order response can be received and processed automatically by the Customer.
3. The Supplier sends an electronic Invoice and, potentially, an electronic Credit Note that can be received and processed by the Customer or a representative acting on its behalf.
4. By reference to the Order and its lines, the Invoice enables automated matching by the Customer via a workflow process.
5. The Invoice and Credit Note content enables the Customer's system to route the document to a specific person, department or unit within the organization; this may be required for authorization etc.
6. The Invoice and Credit Note must comply with the commercial and fiscal requirements of the country where the Supplier is registered.
7. The Invoice and Credit Note content facilitates automatic validation of legal and tax values, tax accounting and payment.

4 Profile detailed description

4.1 Context

The specification contained in this document is relevant within the following context:

Categories	Description and Values
Business Process	Ordering - Billing
Product Classification	All types of goods and/or services.
Industry Classification	Buyer and Seller organisations in all sectors, public and private
Geopolitical	Europe
Official Constraint	EU Directive 2006/112 (VAT directive)
System Capabilities	None specific.

4.2 Business process in scope

Post award procurement is a complex domain with several key processes, some of which are illustrated in the following figure.

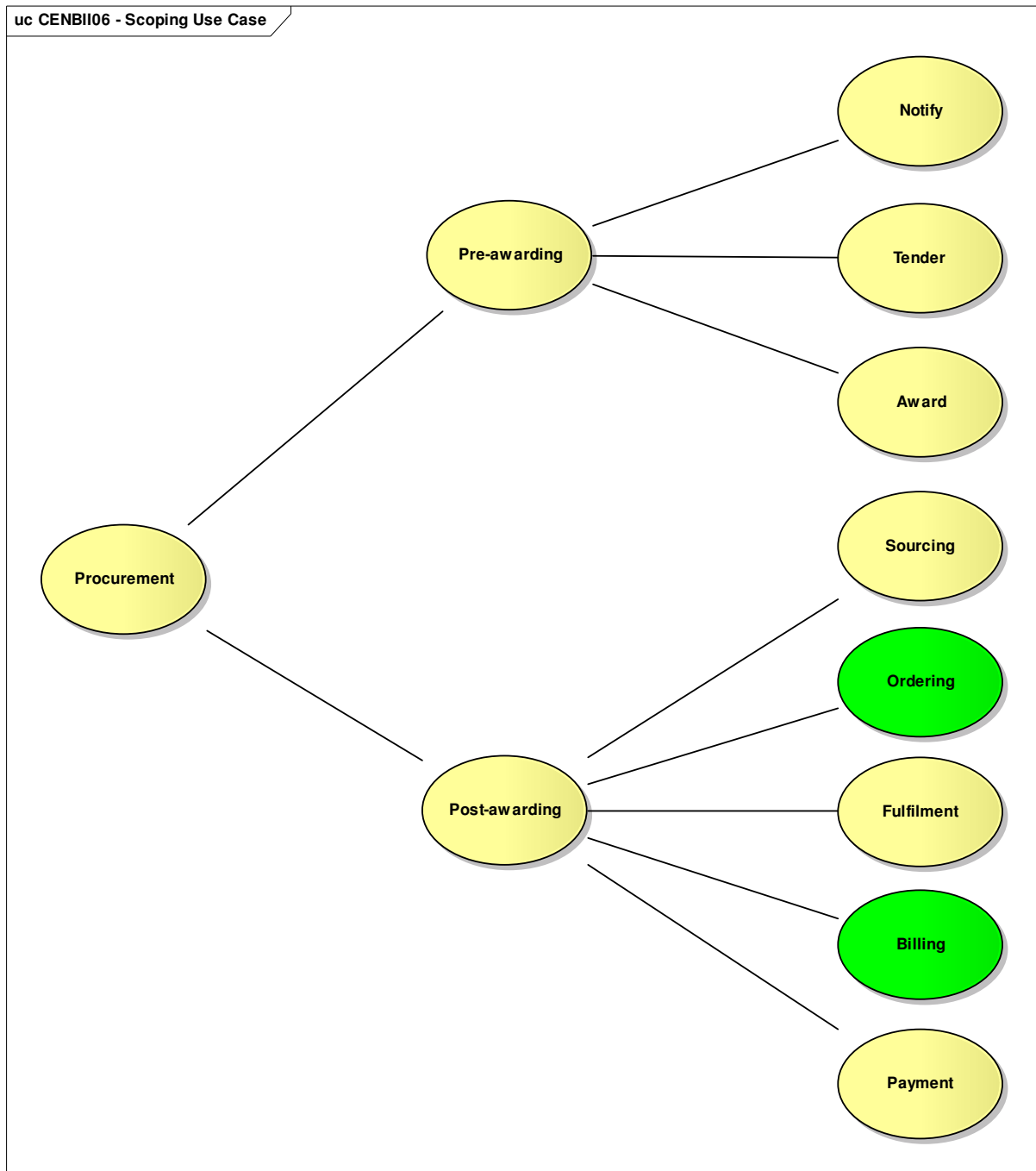

The Procurement profile covers the following business processes highlighted in the above figure.

4.3 The actors involved in this profile are:

The following business partners participate in this profile, acting in the roles as defined below.

Business partners	Description
Customer	The customer is the legal person or organization who is in demand of a product or service. Examples of customer roles: buyer, consignee, debtor, contracting authority.

Supplier	<p>The supplier is the legal person or organization who provides a product or service.</p> <p>Examples of supplier roles: seller, consignor, creditor, economic operator.</p>
----------	---

Role/actor	Description
Buyer	The buyer is the legal person or organization acting on behalf of the customer and who buys or purchases the goods or services.
Seller	The seller is the legal person or organization acting on behalf of the supplier and who sells goods or services to the customer.
Creditor	<p>One to whom a debt is owe. The Party that claims the payment and is responsible for resolving billing issues and arranging settlement. The Party that sends the Invoice.</p> <p>Also known as Invoice Issuer, Accounts Receivable, Seller.</p>
Debtor	<p>One who owes debt. The Party responsible for making settlement relating to a purchase.</p> <p>The Party that receives the Invoice.</p> <p>Also known as Invoicee, Accounts Payable, Buyer.</p>

The following diagram links the business processes to the roles performed by the Business Partners.

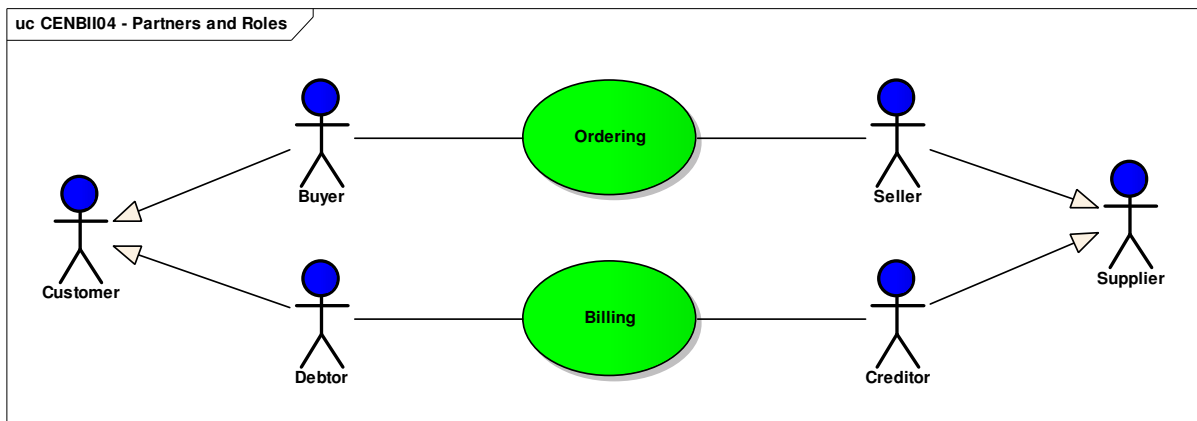

4.4 Choreography of business collaborations

Each business process in scope contains within itself one or more business collaborations:

Business Process	Business Collaboration(s)	Collaboration ID
Ordering	Ordering	BiiColl001
	OrderResponse	BiiColl003
Billing	Invoicing	BiiColl004
	ResolveInvoiceDispute	BiiColl005

The following diagram shows the relationships (i.e. links) between the collaborations of each business process implemented by the profile. The choreography of business collaborations defines the sequence of interactions when the profile is run within its context. Each sequence of interactions can be understood as a run-time scenario.

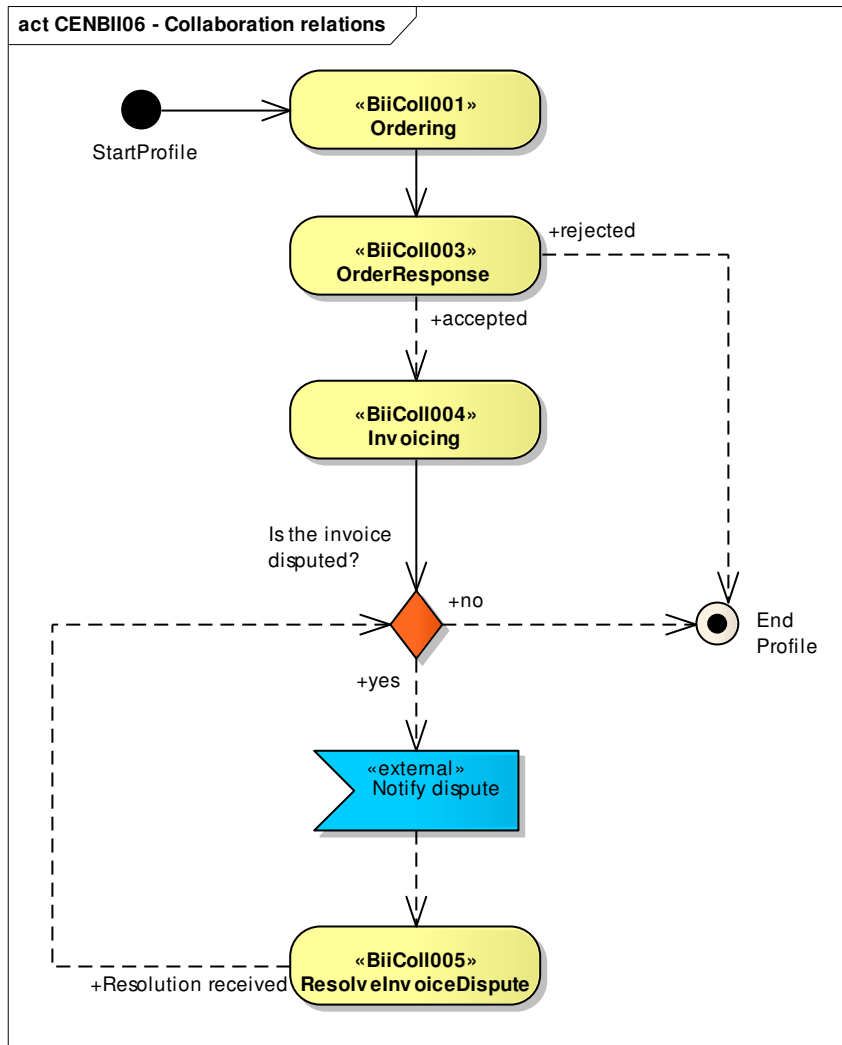

<p>Description</p>	<p>The Customer sends an order which the Supplier either accepts or rejects in full.</p> <p>Following an accepted order the Supplier sends an invoice to the customer.</p> <p>There can be dispute scenarios of: overcharge, undercharge or incorrect information. The creditor corrects the disputed invoice either:</p> <ul style="list-style-type: none"> - By issuing a credit note, - An additional invoice, - By cancelling the original Invoice and issuing a new one. - By providing additional documentation.
<p>Pre-conditions</p>	<p>The Customer and the Supplier have identified each other.</p> <p>The Supplier has agreed to accept electronic orders.</p> <p>The Customer has agreed to accept electronic order response, electronic invoices and electronic credit notes that use the profile.</p>

Post-conditions	In the case of a rejected order, no commitments exist between the Customer and the Supplier.
Scenarios	Accepted Order, accepted Invoice. Rejected Order. Accepted Order, Invoice overcharge. Accepted Order, Invoice undercharge. Accepted Order, Invoice contains wrong information. Accepted Order, Invoice missing supporting docs.
Exceptions	The notification of invoice errors is handled externally.
Remarks	None

4.4.1 Profile business rules

4.4.1.1 Process rules

1. If the process results in an accepted order i.e. a contract is established, the Supplier is obliged to deliver the goods and/or services and the Customer is obliged to pay for those goods and services under the agreed terms and conditions.
2. Referenced contracts such as framework agreements supersede the transactions content.

4.4.1.2 Information constraints

ID	Data element	Context	Severity	Rule description
1	Order reference	Invoice	Hard	An Invoice must reference the Order.
2	Invoice reference	CreditNote	Hard	A Credit Note must reference the invoice that is being corrected.
3	Invoice reference	Corrective Invoice	Hard	A Corrective Invoice must reference the Invoice that is being corrected.

4.5 Business collaboration(s) detailed description

4.5.1 Ordering collaboration

4.5.1.1 Overview

Categories	Description and Values
Collaboration ID	BiiColl001
Description	A Buyer sends an order to a Seller for any goods or services.
Pre condition	None.
Post condition(s)	Order has been submitted.
Transactions	SubmitOrder – BiiTrns001
Roles	Buyer Seller

4.5.1.2 Diagram

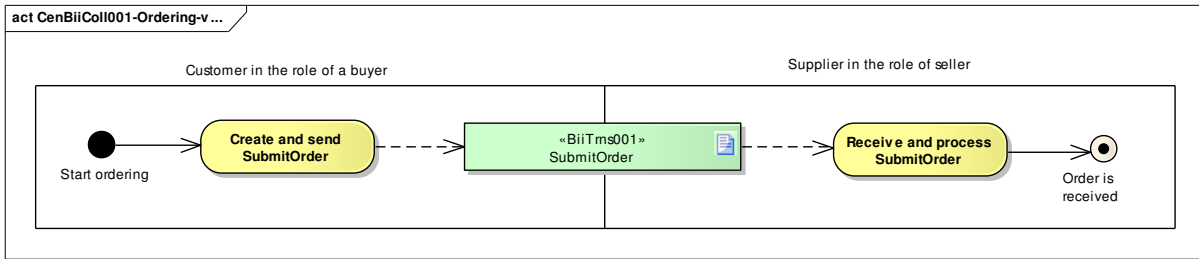

4.5.1.3 Activity description

Role	Activity	Description
Main flow		Order submitted
Buyer	Create and send SubmitOrder	The Buyer creates and sends a SubmitOrder transaction to the Seller.
Seller	Receive and process SubmitOrder	Seller receives and processes the SubmitOrder transaction.

4.5.1.4 Collaboration business rules

4.5.1.4.1 Process rules

1. By sending a SubmitOrder transaction the Buyer is legally committed to its content in accordance with terms specified in the transaction itself or referenced external documentation, i.e. if the Order is accepted in full within its validity period a contract will be established and the Buyer will be obliged to pay for those goods and services under the agreed terms and conditions.
2. Each order is complete and does not inherit from referenced orders.
3. Delivery details stated at document level must apply to all order lines.
4. Payment Means and Terms stated at document level must apply to all order lines.
5. Accounting details stated at document level must apply to all order lines.
6. An order line may contain an identified item or an item with a free text description.

4.5.1.4.2 Information constraints

Information constraints relevant to this collaboration are captured in the referenced transaction data model(s).

4.5.2 OrderResponse collaboration

4.5.2.1 Overview

Categories	Description and Values
Collaboration ID	BiiColl003
Description	The Seller responds to an order with a simple acceptance or rejection, stating whether he will supply the ordered items in full or not at all.
Pre condition	The Seller has received an order from the Buyer
Post condition(s)	<ol style="list-style-type: none"> a. The Seller has accepted the order in full and thus established a contract. b. The Seller has rejected the order in full.
Transactions	RejectOrder – BiiTrns002 AcceptOrder – BiiTrns003
Roles	Buyer Seller

4.5.2.2 Diagram

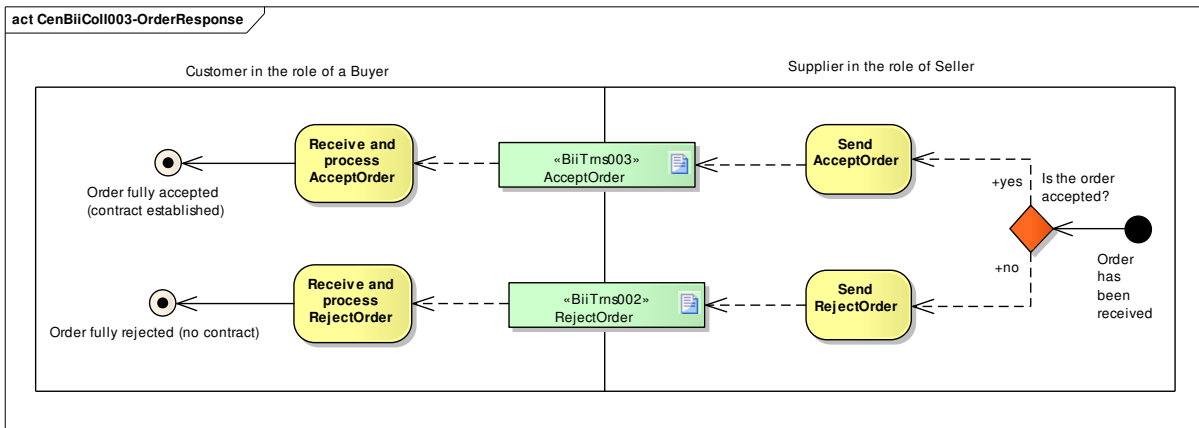

4.5.2.3 Activity description

Role	Activity	Description
Main flow	Order accepted	Post condition a
Seller	Send AcceptOrder	The seller creates and sends an AcceptOrder transaction and thus fully accepts the order.
Buyer	Receive and process AcceptOrder.	The buyer receives and processes the AcceptOrder.
Scenario	Order rejected	Post condition b
Seller	Send RejectOrder.	The seller creates and sends a RejectOrder transaction and thus fully rejects the order.
Buyer	Receive and process RejectOrder.	The buyer receives and processes the RejectOrder.

4.5.2.4 Collaboration business rules

4.5.2.4.1 Process rules

1. By sending AcceptOrder transaction the Seller agrees to all content of the Order including payment terms, delivery terms etc. By sending a positive AcceptOrder within the validity period of the Order a contract is established and the Seller is obliged to deliver the goods and/or services and the Buyer is obliged to pay for those goods and services under the agreed terms and conditions.
2. By sending a RejectOrder transaction the Seller rejects the referenced Order in full, no contract is established and there are no legal implications on any of the parties. No commitment is imposed on either partner and the Buyer is relieved from his commitment to the order.
3. The Seller may not fulfil an order before sending an AcceptOrder transaction to the Buyer, as the AcceptOrder is a prerequisite for establishing the contract.

4.5.2.4.2 Information constraints

Information constraints relevant to this collaboration are captured in the referenced transaction data model.

4.5.3 Invoicing collaboration

4.5.3.1 Overview

Categories	Description and Values
Collaboration ID	BiiColl004
Description	The collaboration is used to deliver an Invoice from a Creditor to a Debtor. It does not require the Debtor to produce any business level response.

Categories	Description and Values
Pre condition	None.
Post condition(s)	The Debtor has received an Invoice
Transactions	SubmitInvoice - BiiTrns010
Roles	Creditor Debtor

4.5.3.2 Diagram

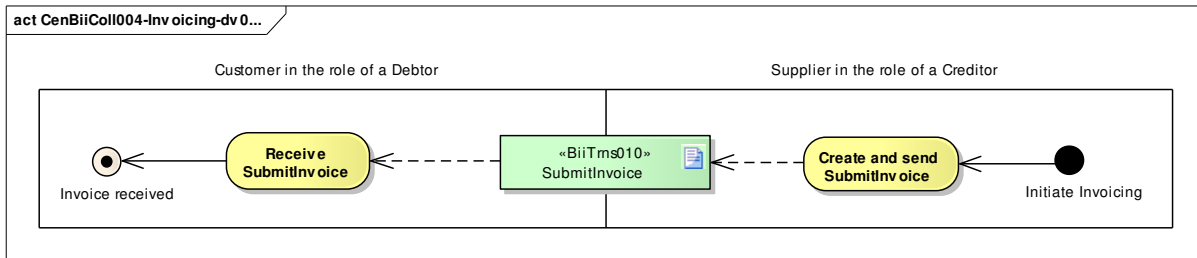

4.5.3.3 Activity description

Role	Activity	Description
Creditor	Create and send SubmitInvoice	The Creditor creates and sends an Invoice to the Debtor.
Debtor	Receive SubmitInvoice	The Debtor receives the Invoice.

4.5.3.4 Collaboration business rules

4.5.3.4.1 Process rules

1. The invoice must comply with the commercial and fiscal requirements of the country where the Supplier is registered.
2. An electronic Invoice represents a legal claim for payment.
3. Payment means and terms stated at document level must apply to all invoice lines.
4. Accounting details stated at document level must apply to all invoice lines.
5. Tax information stated at document level must apply to all invoice lines.
6. Stated pre-payments must apply to the invoice as a whole.

4.5.3.4.2 Information constraints

Information constraints relevant to this collaboration are captured in the referenced transaction data model(s).

4.5.4 ResolveInvoiceDispute collaboration

4.5.4.1 Overview

Categories	Description and Values
Collaboration name	ResolveInvoiceDispute
Collaboration ID	BiiColl005
Description	Following a disputed invoice this collaboration is used to exchange documents to resolve the invoice dispute.

Categories	Description and Values
Pre condition	The Debtor has received an invoice, which he has disputed.
Post condition(s)	<ul style="list-style-type: none"> a. The Debtor has received a resolution to the dispute. b. The Creditor has recognized that the dispute concerns a request for additional documents.
Transactions	CorrectWithCredit - BiiTrns014 CorrectWithInvoice - BiiTrns015
Roles	Creditor Debtor

4.5.4.2 Diagram

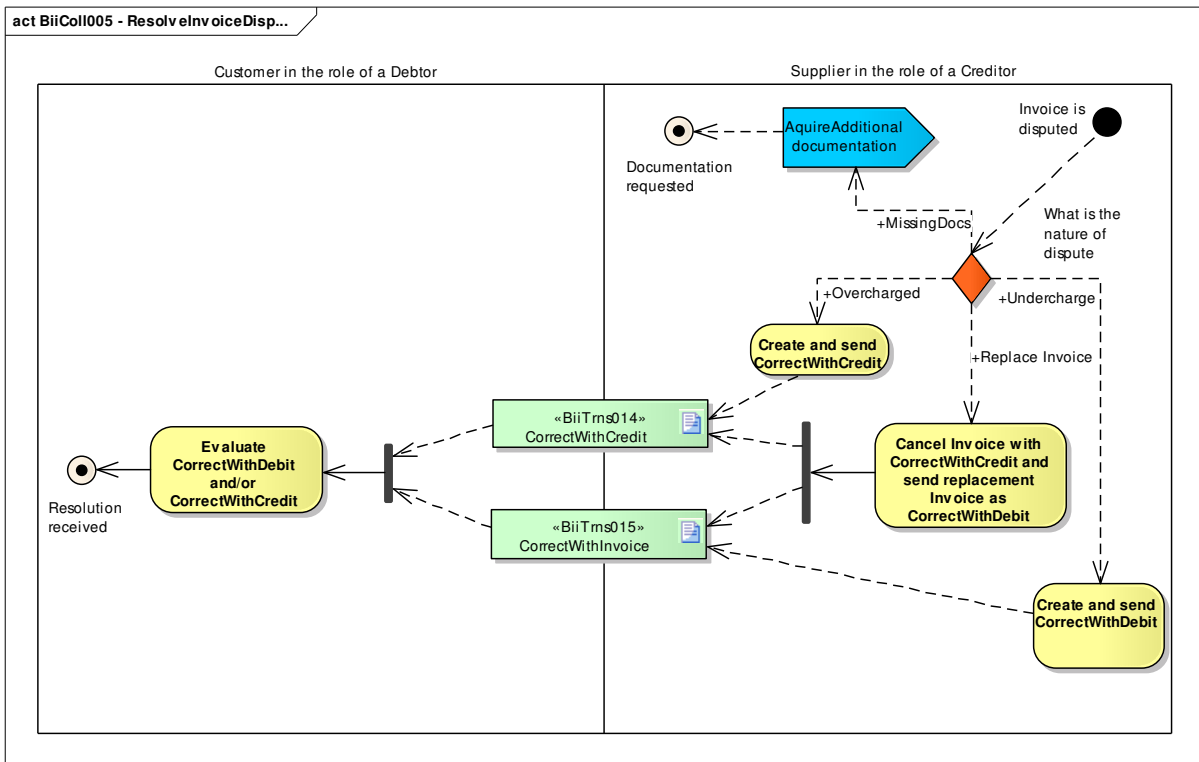

4.5.4.3 Activity description

Role	Activity	Description
Scenario	All	
Creditor	External reception of a dispute.	The Creditor has externally received a dispute to an invoice and proceeds to identify how to resolve it.
Scenario	Overcharge	
	Create and send CorrectWithCredit.	If there is an overcharge, which is resolved by giving credit, the Creditor creates and sends a CorrectWithCredit transaction to the Debtor.
Scenario	Undercharge	
	Create and send CorrectWithInvoice.	If there is an undercharge, which is resolved by issuing an additional invoice, the Creditor creates and sends a CorrectWithInvoice transaction to the Debtor.
Scenario	Replace Invoice	

	Cancel invoice with CorrectWithCredit and send replacement invoice as CorrectWithInvoice.	If the Creditor decides to resolve the disputed invoice by replacing it, the Creditor creates and sends a CorrectWithCredit transaction (zero balancing the disputed Invoice) and also sends a new replacement invoice by using a CorrectWithInvoice transaction.
Scenario	All above	Post condition a
	Evaluate CorrectWithCredit and/or CorrectWithInvoice.	The Debtor receives and processes the CorrectWithCredit - and/or CorrectWithInvoice transactions and proceeds to verify that they sum up to the right amount and/or information has been corrected.
Scenario	Missing Doc	Post condition b
	Acquire additional documentation.	The Creditor identifies that the nature of the dispute is a request for additional documents and he proceeds to provide those documents externally.

4.5.4.4 Collaboration business rules

4.5.4.4.1 Process rules

1. The credit note and corrective invoice must comply with the commercial and fiscal requirements of the country where the Supplier is registered.
2. A CorrectWithCredit represents reduction of the claim for payment made in the referenced invoice.
3. Payment means and terms stated at document level apply to all CorrectWithCredit lines.
4. Accounting details stated at document level apply to all CorrectWithCredit and/or CorrectWithInvoice lines.
5. Tax information stated at document level applies to all CorrectWithCredit and/or CorrectWithInvoice lines.

4.5.4.4.2 Information constraints

- None specified.

4.6 Transaction(s) detailed description

The figure below identifies the electronic messages exchanged as part of this process and the sequence in which these documents are exchanged.

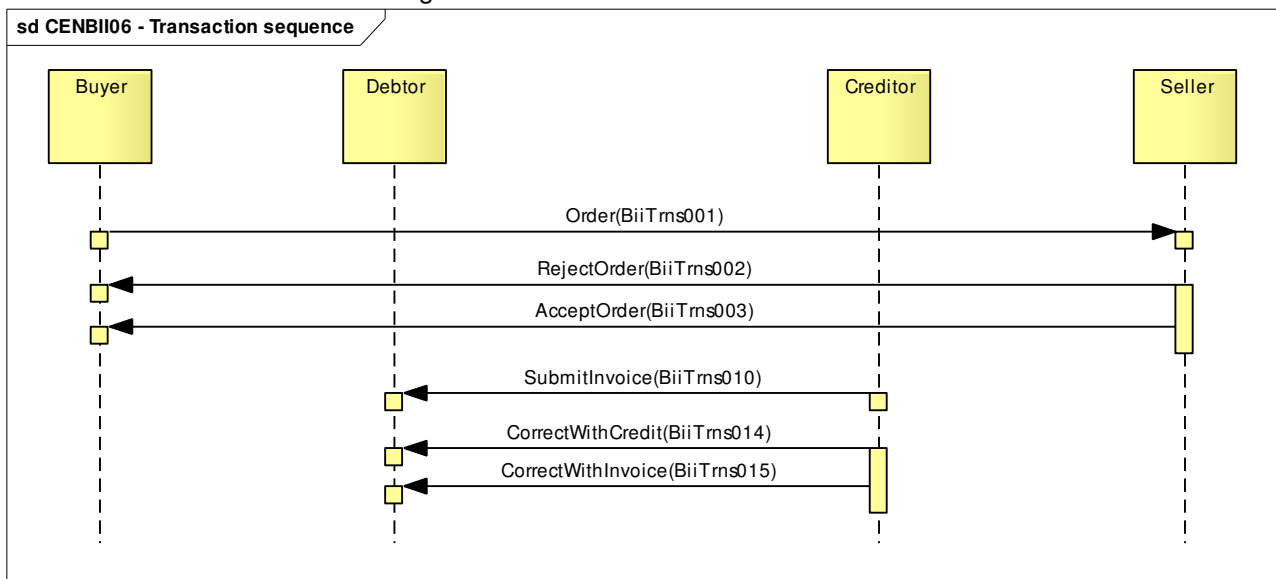

4.6.1 Transaction data models

Transaction	Trns ID	Data Model	Data model ID, Core - Full
SubmitOrder	BiiTrns001	Order	BiiCoreTrdm001 - BiiFullTrdm001

Transaction	Trns ID	Data Model	Data model ID, Core - Full
RejectOrder	BiiTrns002	OrderRejection	BiiCoreTrdm002 - BiiFullTrdm002
AcceptOrder	BiiTrns003	OrderAcceptance	BiiCoreTrdm003 - BiiFullTrdm003
SubmitInvoice	BiiTrns010	Invoice	BiiCoreTrdm010 - BiiFullTrdm010
CorrectWithCredit	BiiTrns014	CreditNote	BiiCoreTrdm014 - BiiFullTrdm014
CorrectWithInvoice	BiiTrns015	CorrectiveInvoice	BiiCoreTrdm015 - BiiFullTrdm015

Each of the identified transactions is elaborated in the following chapters.

4.6.2 SubmitOrder transaction

Categories	Description and values
Identifier	BiiTrns001
Description	A structured electronic business document that contains information directly relating to the economic event of ordering products and/or services. A document that is used by a Buyer to initiate a transaction with a Seller for the supply of goods or services as specified, according to conditions set out in a reference quote, catalogue, counter offer, framework agreement, contract or otherwise known to the Buyer.
Partner Types	Customer Supplier
Authorized Roles	Buyer Seller
Legal Implications	None specified.
Initial Event	Create and send SubmitOrder.
Terminal event	Receive and process SubmitOrder.
Scope	To send a new order.
Boundary	Not used for changed orders as response to counter offers.

4.6.2.1 Transaction business rules

- None specified.

4.6.3 RejectOrder transaction

Categories	Description and Values
Identifier	BiiTrns002
Description	A structured electronic business document for fully rejecting a single order that has been received.
Partner Types	Customer Supplier
Authorized Roles	Seller Buyer
Legal Implications	None specified.
Initial Event	Send RejectOrder.

Categories	Description and Values
Terminal event	Receive and process RejectOrder.
Scope	To reject orders in full.
Boundary	Only used for full order rejection.
Constraints	None specified.

4.6.3.1 Transaction business rules

- None specified.

4.6.4 AcceptOrder transaction

Categories	Description and Values
Identifier	BiiTrns003
Description	A structured electronic business document for fully accepting a single order received.
Partner Types	Customer Supplier
Authorized Roles	Seller Buyer
Legal Implications	Establishes a contract based on the accepted order.
Initial Event	Send AcceptOrder.
Terminal event	Receive and process AcceptOrder
Scope	To fully accept orders.
Boundary	None specified.

4.6.4.1 Transaction business rules

- None specified.

4.6.5 SubmitInvoice transaction

Categories	Description and Values
Identifier	BiiTrns010
Description	A structured electronic business document claiming payment for goods or services supplied under conditions agreed between the Supplier and the Customer. In most cases this document describes the actual financial commitment of goods or services ordered from the Supplier.
Partner Types	Customer Supplier
Authorized Roles	Creditor Debtor
Legal Implications	See business rules below.
Initial Event	Create and send invoice.
Terminal event	Receive Invoice.

Categories	Description and Values
Scope	Invoicing for any goods and services.
Boundary	None
Constraints	See business rules below

4.6.5.1 Transaction business rules

1. An invoice containing VAT information must comply with VAT rules of the country where supplier is registered. If supplier and buyer are registered within the same country, the invoice must comply with the commercial and fiscal requirements of that country.

4.6.6 CorrectWithCredit transaction

Categories	Description and Values
Identifier	BiiTrns014
Description	A structured electronic business document for a Creditor to specify a reduced payment in reference to an Invoice or to cancel that Invoice fully.
Partner Types	Customer Supplier
Authorized Roles	Debtor Creditor
Legal Implications	None specified.
Initial Event	Create and send CorrectWithCredit
Terminal event	Receive and process CorrectWithCredit
Scope	To reduced the amount claimed in an invoice or to nullify (cancel) an invoice in full.
Boundary	Only used in relation to an existing invoice.
Business rules	None specified.

4.6.6.1 Transaction business rules

- None specified.

4.6.7 CorrectWithInvoice transaction

Categories	Description and Values
Identifier	BiiTrns015
Description	A structured electronic business document that adds to or replaces an existing invoice.
Partner Types	Customer Supplier
Authorized Roles	Creditor Debtor
Legal Implications	None specified.
Initial Event	Create and send CorrectiveInvoice.

Categories	Description and Values
Terminal event	Receive and CorrectiveInvoice.
Scope	Corrective invoice in the case of an undercharge.
Boundary	Only used in relation to an existing invoice.
Constraints	None specified.

4.6.7.1 Transaction business rules

- None specified.